

GENPOD® I50

HFE INTERNATIONAL

OWNER'S MANUAL



HFEDCN0629
Revision B



- SPECIFICATIONS..... 2**
- SAFETY PRECAUTIONS 4**
- FUEL REQUIREMENTS 5**
- COMPONENT IDENTIFICATION..... 6**
- INSTALLATION AND STARTING..... 9**
 - INSTALLATION..... 9**
 - THROTTLE, COMMUNICATION, AND ENABLE SETUP..... 11**
 - ENGINE STARTING..... 12**
 - STARTING AGAIN AFTER FIRST START..... 12**
 - REMOVING THE ENGINE..... 13**
- INTERFACE SPECIFICATIONS..... 14**
- MAINTENANCE 18**
 - Torque Specifications 18**
 - Maintenance Schedule 18**
 - Fuel Filter Replacement..... 19**
- TROUBLESHOOTING..... 21**
- MAX POWER WORKSHEET 24**
- PARTS LIST 27**
- WARRANTY..... 28**

Document Revision Table

Rev	Description of change	Revised by	Revision Date	Approved By	Approved Date
A	Initial Release	KGRATIEN	12/15/2022	DRB	12/16/2022
B	Picture and table updates	KGRATIEN	12/20/2022	DRB	12/20/2022

SPECIFICATIONS

Metric	Value (SI)	Value (SAE)
Actual displacement	150 cc	10.4 in ³
Momentary Peak Power @ rated RPM	7.7 kW @ 7000 RPM	10.4 hp @ 7000 RPM
Max Continuous Power	7.3 kW @ 6500 RPM	9.8 hp @ 6500 RPM
Peak Torque @ RPM	12.2 NM @ 5000 RPM	9 ft lbs @ 5000 RPM
Max Torsional Impulse	25 NM	18.4 ft lbs
Cruise BSFC @ RPM	460 g/kW-hr @ 5000 RPM	0.76 lb/hP-hr @ 5000 RPM
Idle BSFC @ RPM	615 g/kW-hr @ 2500 RPM	1.01 lb/hP-hr @ 2500 RPM
Do Not Exceed Max RPM	7500 RPM	7500 RPM
Rated (useable) Max RPM	7000 RPM	7000 RPM
Standard Operating RPM Range	2250 – 7000 RPM	2250 – 7000 RPM
Full System Weight with mufflers	6.9 kg	15.2 lb
Full System Power to Weight Ratio	1.06 kW/kg	0.64 hp/lb.
Generator Operating RPM	2000 RPM to 7000 RPM	2000 RPM to 7000 RPM
Nominal Current Draw (12V)	0.5 A	0.5 A
Maximum Current Draw (12V)	1 A	1 A
Rated Max CHT	130 °C	270 °F
Do Not Exceed CHT	190 °C	375 °F
CHT after warm up	65 °C	150 °F
Rated Ambient Minimum	-18 °C	0 °F
Rated Ambient Maximum	49 °C	120 °F
Nominal Dynamic Compression	9 bar	130 psi
Compression Ratio	8.5 : 1	8.5 : 1
Time between overhauls	300 Hrs	300 Hrs
Sound Level	TBD	TBD

**DA150 EFI Stock Muffler Steady State WOT Curve
(Altitude Corrected per SAE J1349)**

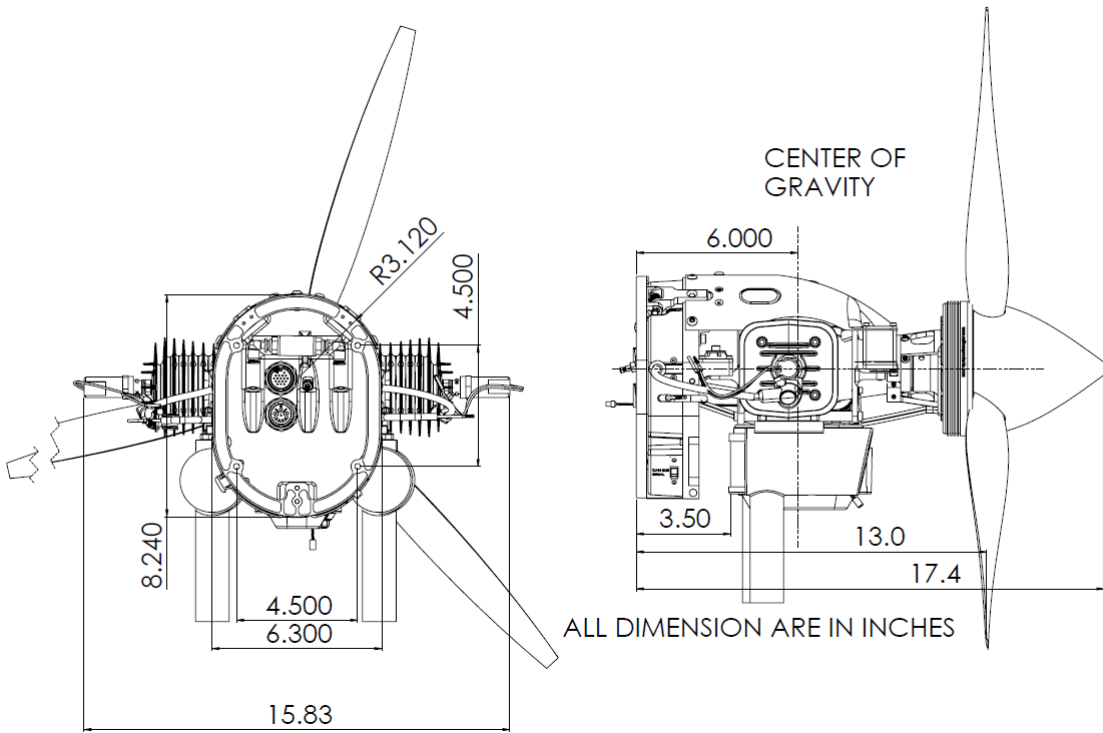
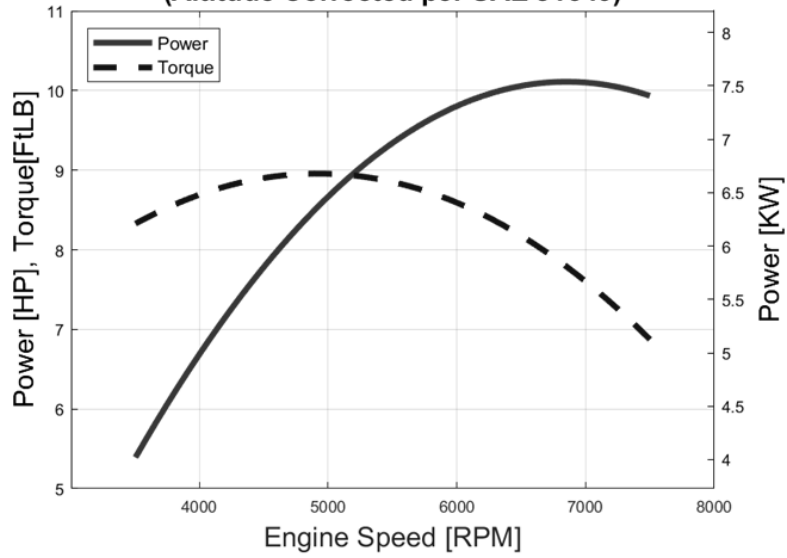

SAFETY PRECAUTIONS

General Safety

Read and understand this Owner's Manual before operating your engine. You can help prevent accidents by being familiar with the controls and observing safe operating procedures.

Operator's Responsibility:

1. The operator should know how to stop the engine quickly in case of an emergency.
2. A safety zone of 3 feet around the propeller should be established in which no person or object is allowed to enter. Install a guard around the propeller when appropriate.



WARNING

1. Observe all safety precautions when working around the propeller.
2. Exhaust contains poisonous carbon monoxide, a colorless and odorless gas. Breathing carbon monoxide can cause loss of consciousness and may lead to death.
3. Never run your engine in an enclosed space. Always allow for appropriate ventilation.
4. Observe precaution around the muffler. The exhaust system gets hot enough to ignite some materials.
5. Keep flammable materials away from the engine.
6. Gasoline is extremely flammable and is explosive under certain conditions. Do not smoke or allow flames or sparks where the engine is operating.

FUEL REQUIREMENTS

Engine Oil

This engine was calibrated using Red Line 2 Stroke Racing oil at a mix ratio of 40:1. This oil type and mix ratio should be maintained to ensure that the fuel injection system and engine operates as designed. If Redline oil is not available, use an equivalent 2T quality two stroke oil for best results.

<p>Oil Brand: Red Line</p> <p>Oil Type: 2 Stroke Racing Oil</p>	
<p>Mix Ratio: 40:1</p> <p>40 parts gasoline to one part oil by volume.</p>	

Fuel Recommendations

The engine was calibrated with standard 87 octane gasoline. Customers may use higher octane fuel if desired. Non-leaded fuels recommended.

Leaded Fuels Warning: When using leaded fuels, the result will be shorter TBO's as a result of lead oxide coking on cylinder and exhaust ports. Leaded fuels will require cylinder, piston, and port, dressing and inspection every 50 to 100 hours (depending on use case). Cylinder dressing and cleaning should be done by a trained professional or by HFE International.

Note: Non-leaded fuels will not require cylinder dressing and may be used continuously until the suggested TBO.

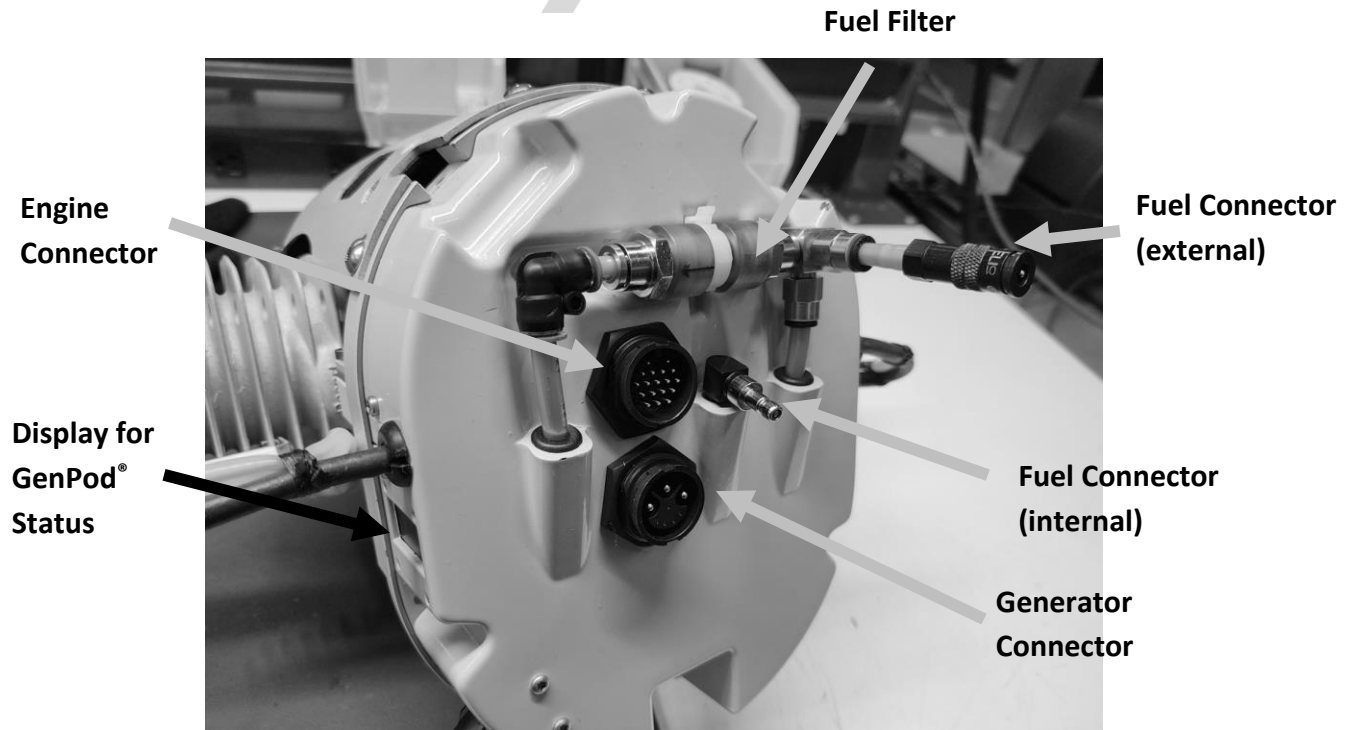

Figure 1. GenPod® Connections and Components

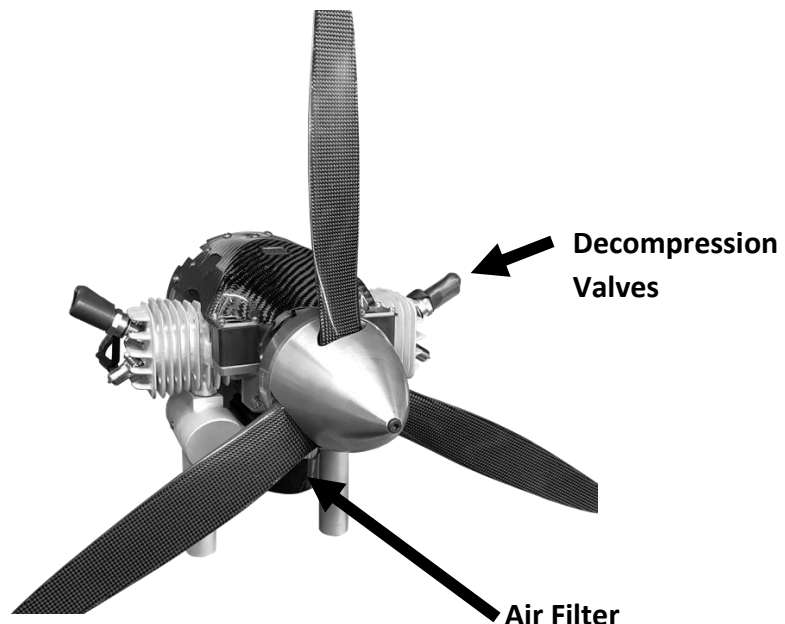
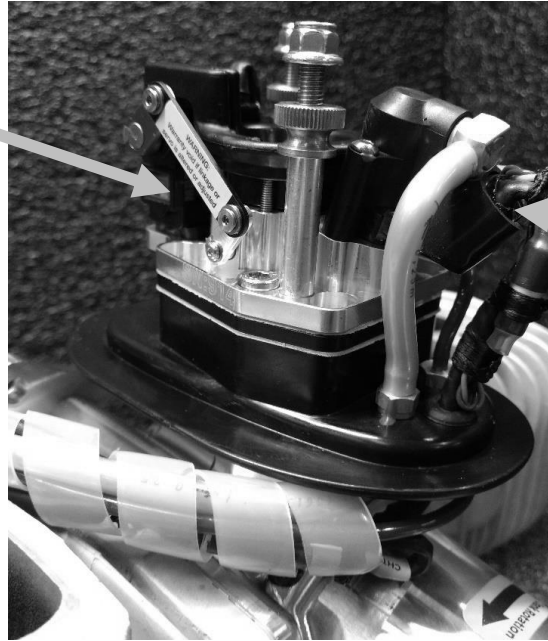

Figure 2. GenPod® Air Filter

Throttle Servo



Injector

Figure 3. Intake Assembly Components

Fuel Fitting



MAP Fitting

Figure 4: Intake Assembly Components

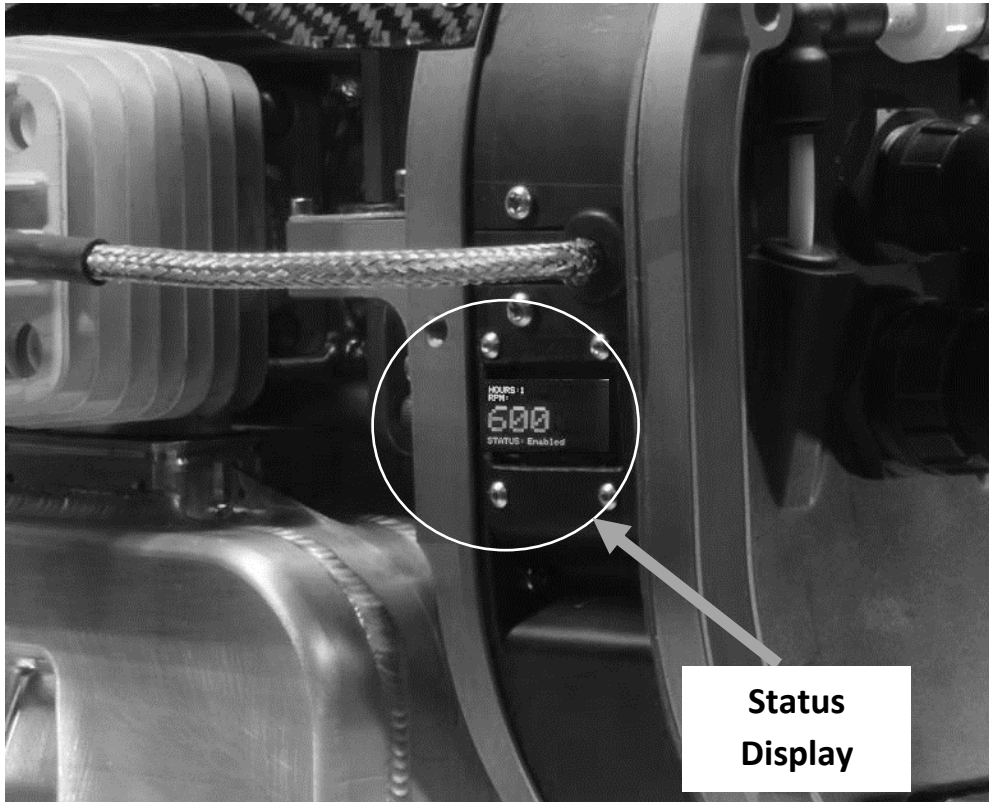

Faults:

- CHT - Cylinder Head Temperature Sensor Fault
- MAT- Manifold air Temperature Sensor Fault
- TPS - No Throttle Command given or throttle command error
- Battery - Power to GenPod® is too high or too low. See Signal input limits.
- RPM - Crank position sensor error.
- Pump - Fuel pressure problem

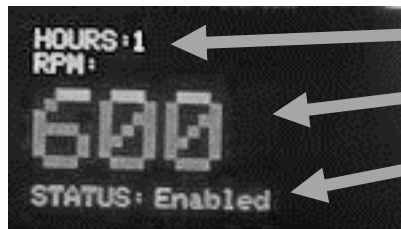

- Engine Hour Meter
- Engine Speed (RPM)
- Engine Status (Enabled / Disabled)



Fault Codes will display in the place of the standard display.

NOTE: display data will only show in CAN BUS communication mode

INSTALLATION AND STARTING

INSTALLATION

1. Install the GenPod® Interface to your aircraft with 4x M5 flat head screws, ensuring that the attachment can handle up to 46 kg (100 lbs.) of thrust and vibration torque impulses as high as 30 N-m (22 ft-lbs) to include a safety factor.

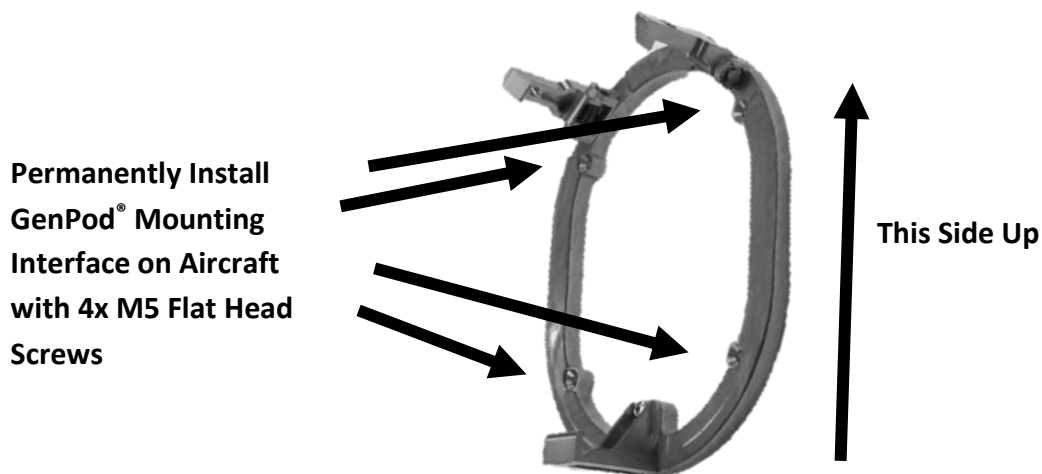
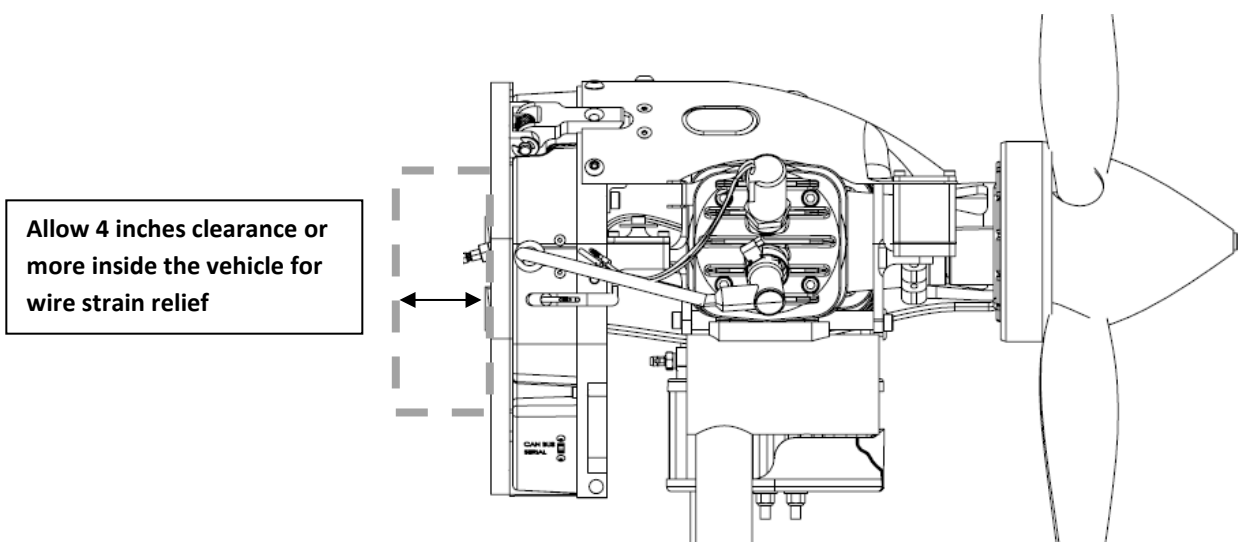

Figure 5. GenPod® Mounting Interface



2. Verify that there is an opening in the center of the GenPod® Interface that allows for the back-shell of the connectors and fuel line to fit once the engine is installed. Verify that there are no sharp edges that the wire harness can chafe on and that the fuel line cannot kink when engine is installed.
3. Connect main harness and PMU inside the aircraft. You may cut and adjust the harness inside the aircraft as needed. Use Mil Spec connectors or similar.
4. Install the 10 micron in tank filter in your fuel tank. Connect the black tubing supplied to the barb connected directly with the filter. This line should tee to run fuel lines to the bulkhead fuel connector, and the inlet of the external fuel pump on the aircraft. The blue tubing should connect to the other barb on the in tank filter, can be used for fueling and defueling. Connect both fuel lines to the mating quick disconnect connector on the back of the Genpod® unit. Connect the engine harness to the Genpod® unit.
5. The GenPod® uses a Sullivan PMU and alternator. Connect the Engine as shown in **Figure 1**.
6. Install the GenPod® to the Interface by resting the pin in the interface hook and latching the two latches on top. Secure the latch with M5 flat head screws before flight.



Figure 6: CAN BUS and Serial Switch

THROTTLE, COMMUNICATION, AND ENABLE SETUP

1. Throttle commands use a standard PWM signal. Expected pulse width range from $900\mu\text{s}$ for closed throttle and $2100\mu\text{s}$ for wide open throttle.
2. To change between CAN BUS and Serial communication, slide the switch located on the Genpod® cover towards the desired protocol (**Figure 6**).
3. (**Throttle kill**) When the pulse width from the receiver falls below $960\mu\text{s}$ (5% throttle), the ECM will remove power to both the injector and ignition system thus stopping the operation of the engine.
4. (**Enable kill**) Provide 5V power to the enable line, when power is removed ECM will remove power to both the injector and ignition system thus stopping the operation of the engine.

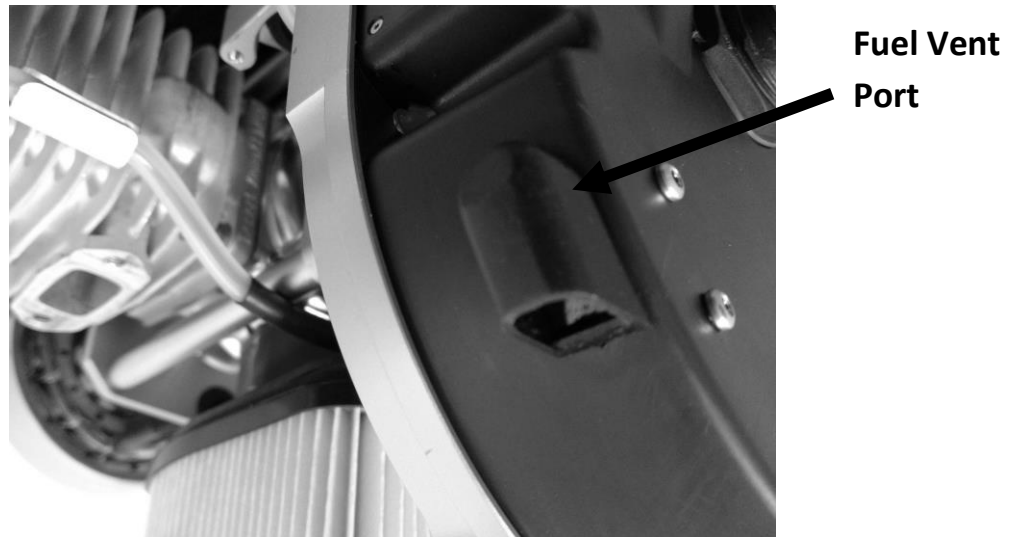

Figure 7. GenPod® Fuel Venting

ENGINE STARTING

1. Verify that the throttle setting is at about 30%.
2. Prime your system for the first time by pressing and holding the fuel vent port when the Genpod® power is on (**Figure 7**). Cycle the battery power to the Genpod® in 5 second intervals until fuel is flowing from the vent port without air. You should not have to complete the priming process again unless the engine fuel system is allowed to run dry or has been disconnected for any reason.
3. The engine should be started using an external hand held starter, or using a built-in starting alternator. **Flip starting is an additional option but is not recommended due to possible injuries.**

Note: The engine may struggle to run for the first few minutes as it is purging all the air from the fuel system. This may not be evident until you go to wide open throttle.

4. Allow the engine to run for a few minutes around 3000 RPM.
5. Keep at wide open throttle for 10 seconds to verify that the air in the fuel system has been purged. Reduce the engine speed to idle.

STARTING AGAIN AFTER FIRST START

1. Verify that the throttle setting is at about 30%.
2. The engine should be started using an external hand held starter, or using a built-in starting alternator. **Flip starting is an additional option but is not recommended due to possible injuries.**
3. Allow the engine to run for a few minutes around 3500 RPM.
4. Keep at wide open throttle for 10 seconds to verify that the air in the fuel system has been purged. Reduce the engine speed to idle.

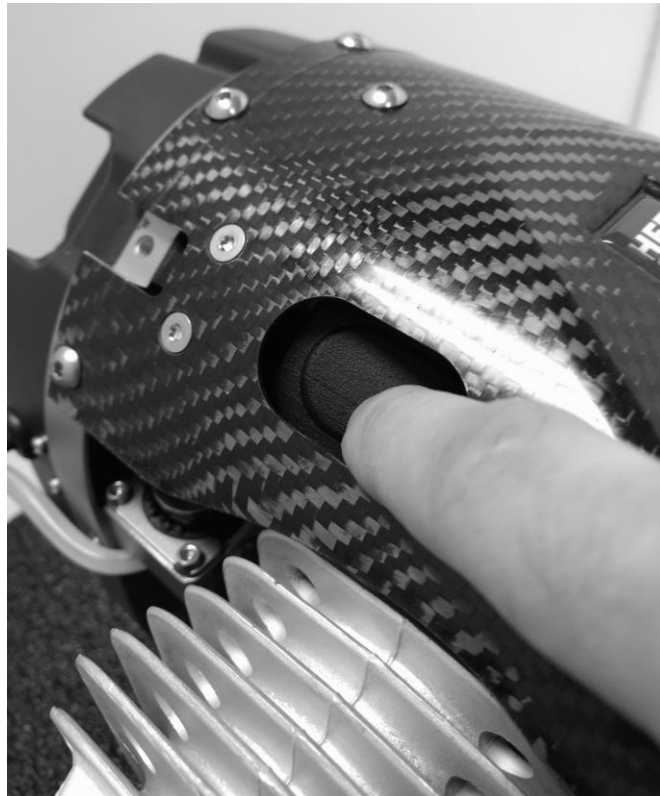

Figure 8: Genpod® Buttons

REMOVING THE ENGINE

1. Remove the M5 flat head screws securing the Genpod® to the latches.
2. Press the buttons as seen in **Figure 8** to lift the latches up. While supporting the Genpod®, lean the Genpod® forward.
3. Disconnect the main harness, the PMU harness, and the fuel connector from the Genpod®.
4. Lift and remove the Genpod®. If the Genpod® is to be shipped, please use the HFE Int. provided packaging.

INTERFACE SPECIFICATIONS

Signal Inputs/Outputs for GenPod®:

Pin	Signal	Color	Description
1	TACH OUT	Brown	+5V logic-level digital output. This pin has a maximum continuous load of $\pm 20\text{mA}$. Output signal has a 50% duty cycle.
2	TX	Blue	RS-232 Transmit
3	CAN HI	White	CAN bus signal High
4	ENABLE (Special feature available on request)	Green	Engine enable signal from Auto Pilot. A 5 volt signal present to enable (UAV option only). This pin has an 8mA draw. 10k pull down resistor.
5	THROTTLE SIGNAL	Yellow	Throttle position with logic-level input. A Pulse Width Modulated (PWM) signal at nominally 50Hz with ON time ranging from 900 μs to 2100 μs corresponding to throttle position (0% to 100%). This pin has an 8mA draw.
6	POWER 12V	Gray	Main power input. 10 to 14 volts. Maximum power draw is 12 W at wide open throttle. (11.1v 3 cell LiPo 2000ma or bigger)
7	RX	Pink	RS-232 Serial Communication Receive
8	CAN LO	Red	CAN bus signal Low
9	NC	Black	No Connect
10	GND (Main Input)	Orange	Main Power Ground
11	GND	Purple	Serial Communication Ground Reference
12	GND	Light Green	CAN Ground Reference
13	GND	Black/White	Enable Ground Reference
14	GND	Brown/White	PWM Signal ground reference
15	NC	Red/White	Not connected
16	GND	Orange/White	Tach Out Ground Reference
17	GND	Green/White	IOT Ground Reference
18	POWER 12V	Blue/White	IOT power input.

Table I: GenPod® Input Connector 18 Pin

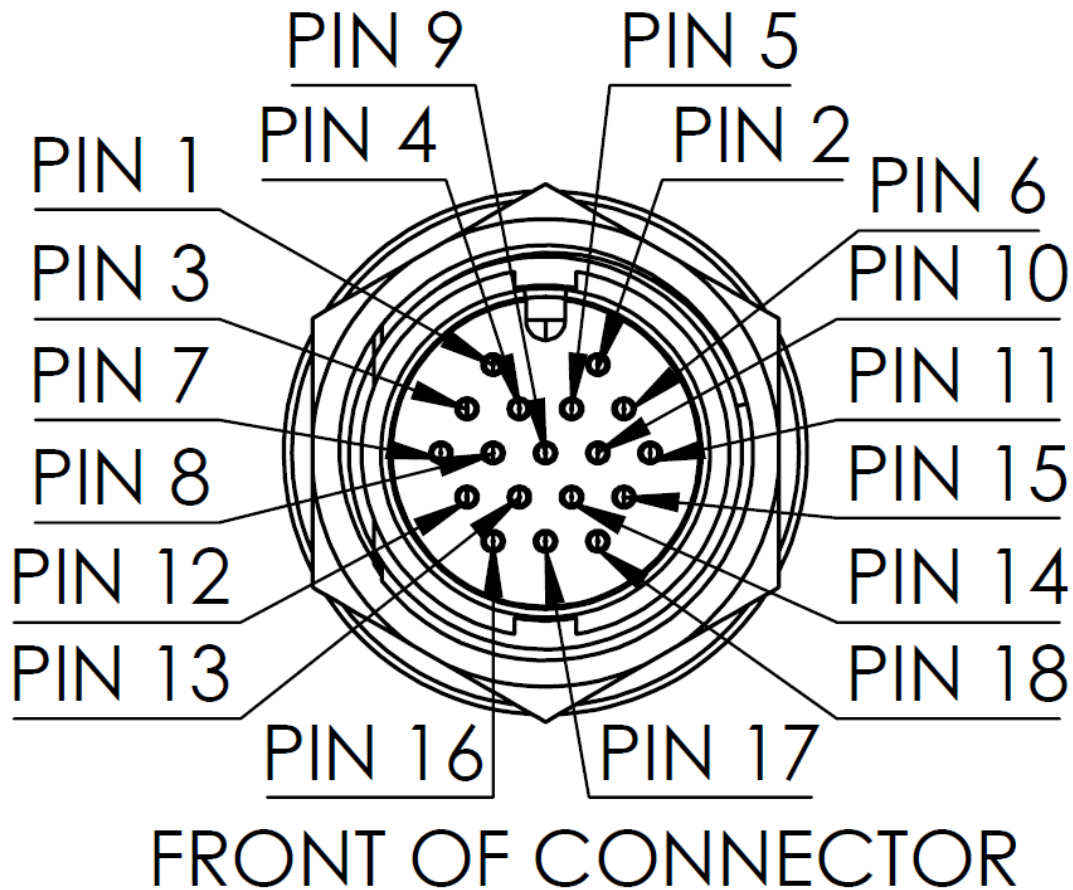

POWER MANAGEMENT UNIT NODE 1

Pin	Signal	Color	Description
1	AC IN 1	RED	3 Phase input 30VAC to 85 VAC
2	AC IN 2	YELLOW	3 Phase input 30VAC to 85 VAC
3	AC IN 3	BLUE	3 Phase input 30VAC to 85 VAC
4	BATTERY +	RED	System battery positive. 6S LiPo 24-30 VDC 150 CCA minimum for starting. Note: LiPo battery charge circuit will enable after engine is running.
5	BATTERY -	BLACK	System battery negative.
6	EXTERNAL +	RED	28V external input. (shore power) Do not exceed 32VDC.
7	EXTERNAL -	BLACK	External input ground.

POWER MANAGEMENT UNIT NODE 2

Pin	Signal	Color	Description
1	START +	GREEN	5V Signal indicates start.
2	START -	BLACK	Start signal ground reference
3	STATUS +	RED	TTL status signal indicates active rectification.
4	STATUS -	BLACK	TTL status signal reference ground

POWER MANAGEMENT UNIT NODE 3

***NOTE:** Primary, Secondary, and Tertiary outputs can be adjusted, within the range specified, based on customer requirements.

Pin	Signal	Color	Description
1	PRIMARY +	RED	Primary Output 24 to 28VDC* de-rated by 6V load on outputs. 12.5A/350W maximum output. Regulated from AC input only. Engine must be running for this output to function.
2	PRIMARY -	BLACK	Primary Ground Reference
3	SECONDARY +	RED	Secondary output = 12 to 15VDC* with 9A/108W maximum output. This output is powered at all times when battery is connected to PMU.
4	SECONDARY -	BLACK	Secondary Ground Reference
5	TERTIARY +	RED	Tertiary output = 5 to 6.5VDC* with 8A/42W maximum output. This output is powered at all times when battery is connected to PMU.
6	TERTIARY -	BLACK	Tertiary Ground Reference

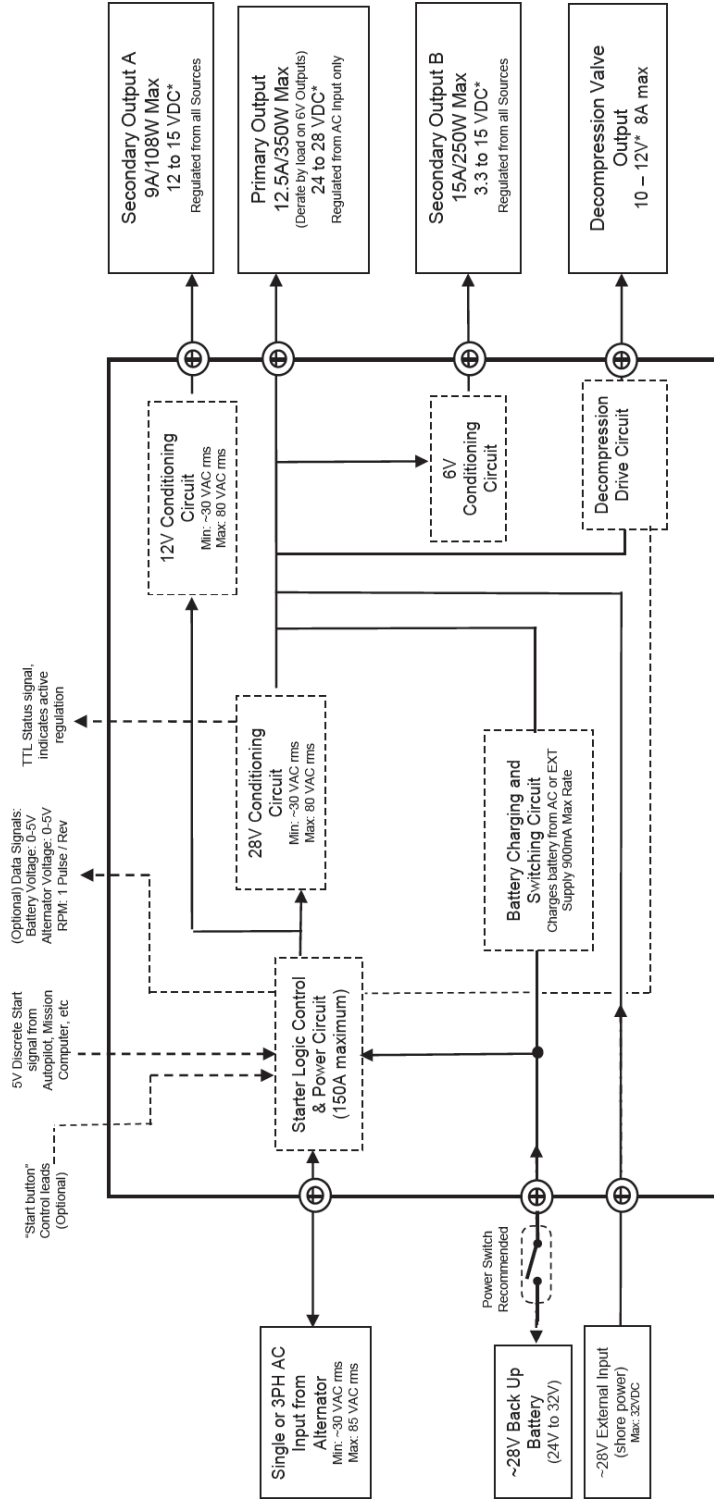

MAINTENANCE

Torque Specifications

Table 2. Torque Specifications

Description	Torque	Type
Spark Plug	10 N-m (90 in-lb)	NGK CM-6
Prop Bolts	10 N-m (90 in-lb)	M5 x 50mm
Spinner Bolts	3.4 N-m (30 in-lb)	M5 x 100 mm
Muffler Bolts	6.8 N-m (60 in-lb)	M5 x 20 mm
Throttle Body Mounting Bolts ¹	5.7 N-m (50 in-lb)	M5
Cylinder Bolts	10 N-m (90 in-lb)	M5 x 16 mm
Crank Case Bolts	10 N-m (90 in-lb)	M5 x 20 mm
Air Filter Torque	1.1 N-m (10 in-lb)	HFE0878

¹Caution: Care must be taken to not over tighten the throttle body mounting bolts. Over tightening can distort and damage the injected molded reed valve parts, rubber gaskets, and throttle body.

Table 3. Spark Plug Gap

Spark Plug Gap	0.38mm to 0.5mm (0.018 to 0.020 inch)
-----------------------	---------------------------------------

Maintenance Schedule

Table 4. Maintenance Schedule

Item	Before Each Flight	Every 50 Hours	Every 100 Hours	Every 300 Hours
Engine Oil Pre-Mix	X			
Spark Plug Check/Adjust		X		
Spark Plug Replace			X	
Air Filter Check/Clean		X		
Air Filter Replace			X	
Fuel Filter Sintered			X	
HFE OEM Maintenance				X

Fuel Filter Replacement

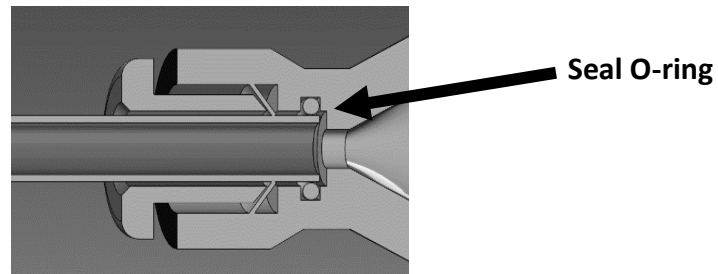

Figure 9. Push-to-Connect Seal

The Genpod® is supplied with 2 filters: One 10 micron in tank filter and one 10 sintered micron filter on the Genpod® unit. When installing the Genpod® unit fuel filter, make sure the push to connect is pushed all the way down to the seal as shown in **Figure 9**.

1. The 10 micron in tank filter can be replaced by gently pushing both locking plastic arms outwards and rotating the filter counterclockwise. A new filter can be installed by rotating it clockwise until it clicks into place.
2. The 10 micron filter is part of the GenPod® and can be found on the back bulkhead. It resides between the fuel pump and the engine. See **Figure 10** for location.

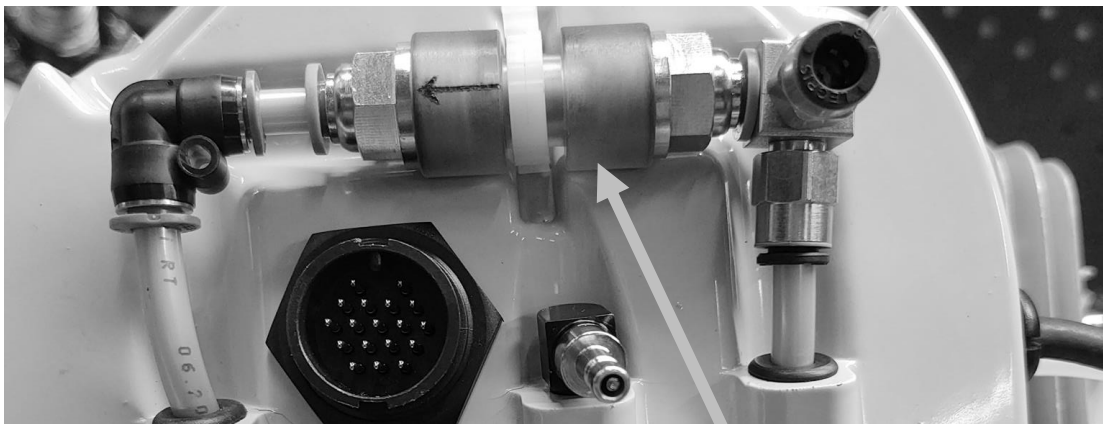

Figure 10. Fuel Filter Location

Air Filter Replacement

10µm Fuel Filter

WARNING: Air filter installation is critical for protecting the throttle body from foreign objects and dust that may jam throttle body components. Make sure the air filter is installed at all times!

Replace air filter as needed by unscrewing the locknuts and pulling the filter off of the throttle body. Re-install the new filter. Do not over-tighten the locknuts. Follow torque specification in **Table 2**.

Only use OEM air filter PN HFE0878.



TROUBLESHOOTING

Engine Does Not Start

No spark at spark plug(s)

Fault	Potential Cause	Corrective Action
Power	GenPod [®] power is not 12 V or does not have enough current capacity when engine is cranking	Repair or diagnose Power Supply. Verify GenPod [®] connector is fully seated.
Enable	Enable signal is not referencing system ground	Tie autopilot ground to GenPod [®] system ground.
	Enable signal is not 5V	Change enable voltage to 5 V
	Throttle Position below 5%	Increase throttle position above 5%
Spark Plug	Gap not correct	Adjust per Table 3
	Wet Spark Plug Electrodes	Remove plugs and let cylinder and plugs dry.
	Carbon Deposit on Electrodes	Replace spark plugs
	Insulator failure or cracked insulator	Replace spark plugs
	Burned electrodes	Replace spark plugs
Ignition	Ignition cap corroded or worn through plating where it contacts spark plug hex.	Return GenPod [®] to HFE International for repair
	Ignition Coil Failure	Return GenPod [®] to HFE International for repair
	Ignition Power	Return GenPod [®] to HFE International for Repair

Miss-firing but not starting (spark is working)

Fault	Potential Cause	Corrective Action
Start Rotation Direction Wrong	Engine is being turned the wrong rotation for starting. (Review the label on the engine for correct prop rotation)	<ol style="list-style-type: none"> 1. If externally started, change manual starter to turn opposite direction. 2. If started with GenPod[®] alternator, disconnect two of the three phase wires and connect them to the opposing lead. Re-start.
Fuel Pressure	Air in fuel lines or fuel lines not connected properly	<ol style="list-style-type: none"> 1. Verify that there is fuel in tank. 2. Remove pod, re-connect fuel lines and follow priming procedure, then re-start.
	Over Pressure	Verify that fuel tank is vented and there is no external pressure on the fuel inlet tube.
	Kink in fuel line	Remove any kinks in fuel lines
Enable	Enable signal is not referencing system ground	Tie autopilot ground to GenPod [®] system ground.
	Enable signal is not 5V	Change enable voltage to 5 V
	Throttle Position below 5%	Increase throttle position above 5%
Spark Plug	Gap not correct	Adjust per Table 3
	Wet Spark Plug Electrodes	Remove plugs and let cylinder and plugs dry.
	Carbon Deposit on Electrodes	Replace spark plugs
	Insulator failure or cracked insulator	Replace spark plugs
	Burned electrodes	Replace spark plugs
No Fuel	Flood Clear Enabled	Reduce throttle position below 35%

Lack of “full power” and/or unstable running

Fault	Potential Cause	Corrective Action
Engine running well but full power is not as high as expected.	Various external causes	See “Power Worksheet” To determine if engine is at max power.
Engine cuts out at Wide Open Throttle	Ignition Coil Failure	Return GenPod® to HFE International.
	Crank Sensor Fault	Return GenPod® to HFE International.
Fuel Pressure	Air in fuel lines or fuel lines not connected properly	1. Verify that there is fuel in tank. 2. Remove pod, re-connect fuel lines and follow priming procedure, then re-start.
	Over Pressure	Verify that fuel tank is vented and there is no external pressure on the fuel inlet tube.
	Kink in fuel line	Remove any kinks in fuel lines
Enable	Enable signal is not referencing system ground	Tie autopilot ground to GenPod® system ground.
	Enable signal is not 5V	Change enable voltage to 5 V
Spark Plug	Gap not correct	Adjust per Table 3
	Wet Spark Plug Electrodes	Remove plugs and let cylinder and plugs dry.
	Carbon Deposit on Electrodes	Replace spark plugs
	Insulator failure or cracked insulator	Replace spark plugs
	Burned electrodes	Replace spark plugs
Throttle valve not opening	Servo failure or linkage jam	Return GenPod® to HFE International.
Fuel	Water in Fuel (if ethanol blend, water can accumulate on the bottom of the tank and cause poor running engine)	Flush fuel tank and re-fill

Power Available Worksheet

Multiply the following percentages together to acquire the total power loss. Use the graphs provided in this section to determine the CHT, MAT electrical power draw, and altitude corrections below.

Table 5. Power Available Calculator

CHT %		MAT %		Electrical Draw %		Altitude %		Total %
	X		X		X		=	

Using RPM to determine power check:

1. Determine total power available by Table 5.
2. Determine expected maximum RPM from Figure 11

Expected RPM for 26x12N 3B Propeller at a Given % Engine Power Available

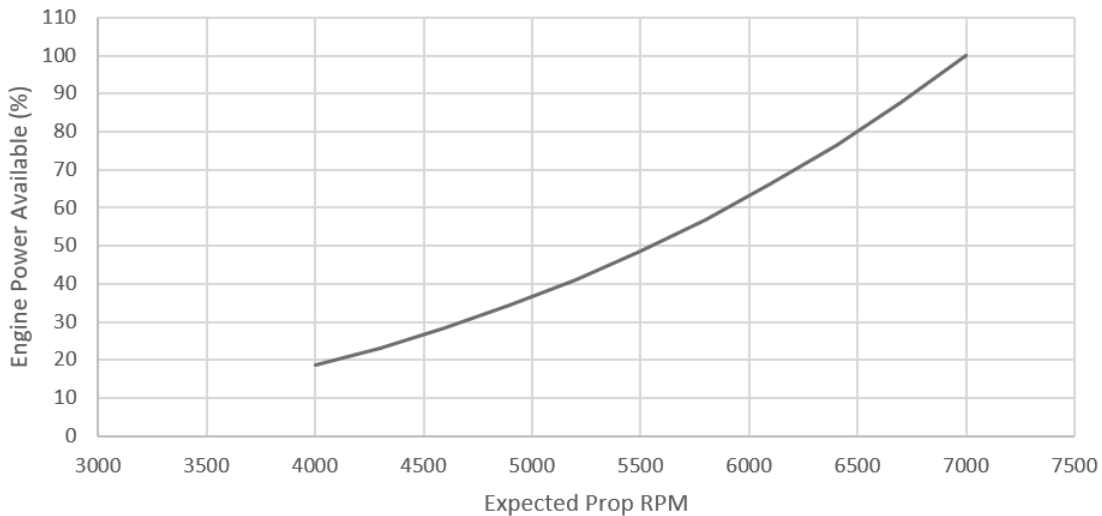
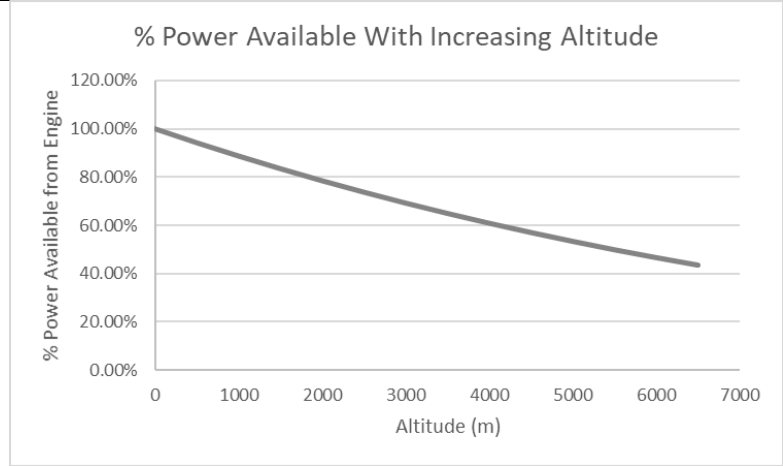
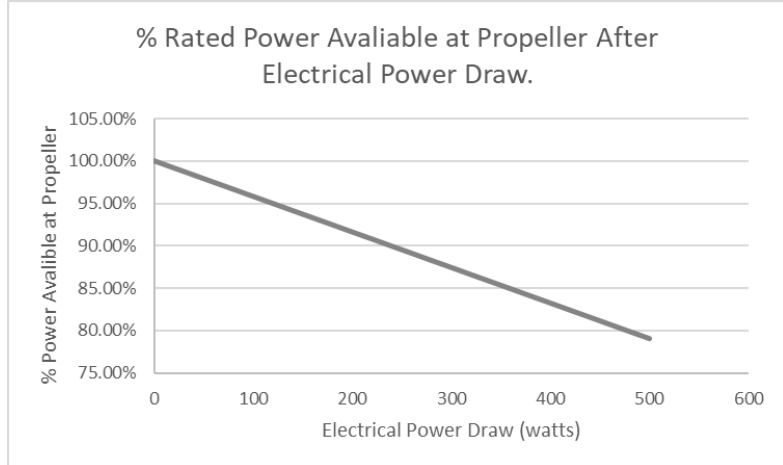

Figure 11. Expected RPM

What is the altitude you are at when doing the max power check? Use this chart to determine what the engine can output at various altitudes.



Determine how much electrical power you are drawing from the generator and PMU system when you are doing the max power test. Use this chart to determine what the engine can output after electrical loads are applied.



When the engine is being tested, record the Cylinder Head Temperature value and determine what the engine power output should be from this chart

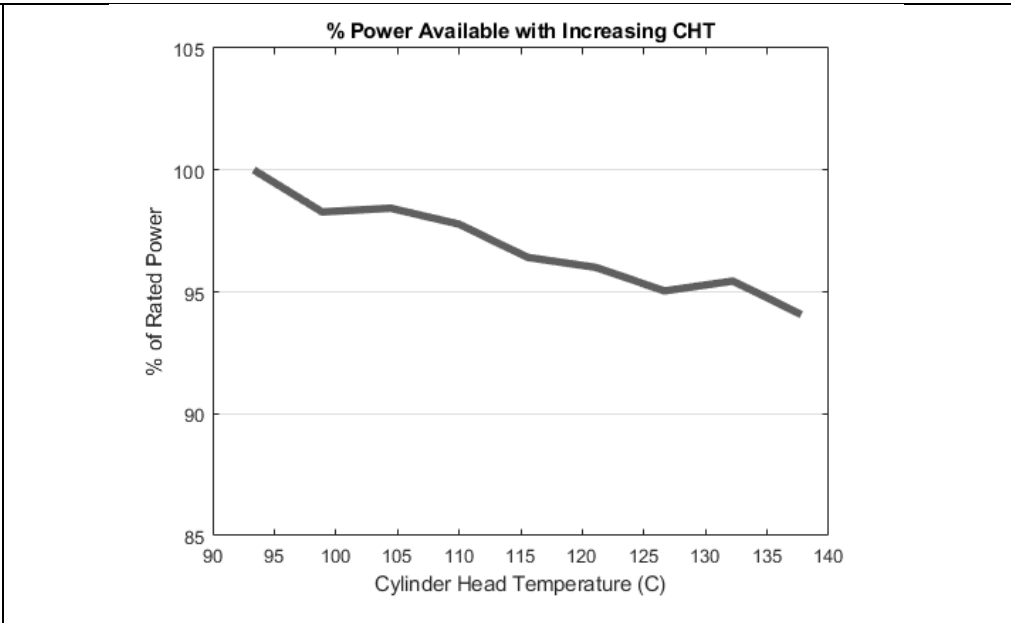

When the engine is being tested, record the value for Manifold Air Temperature and use it to determine what the engine power output would be from this chart.

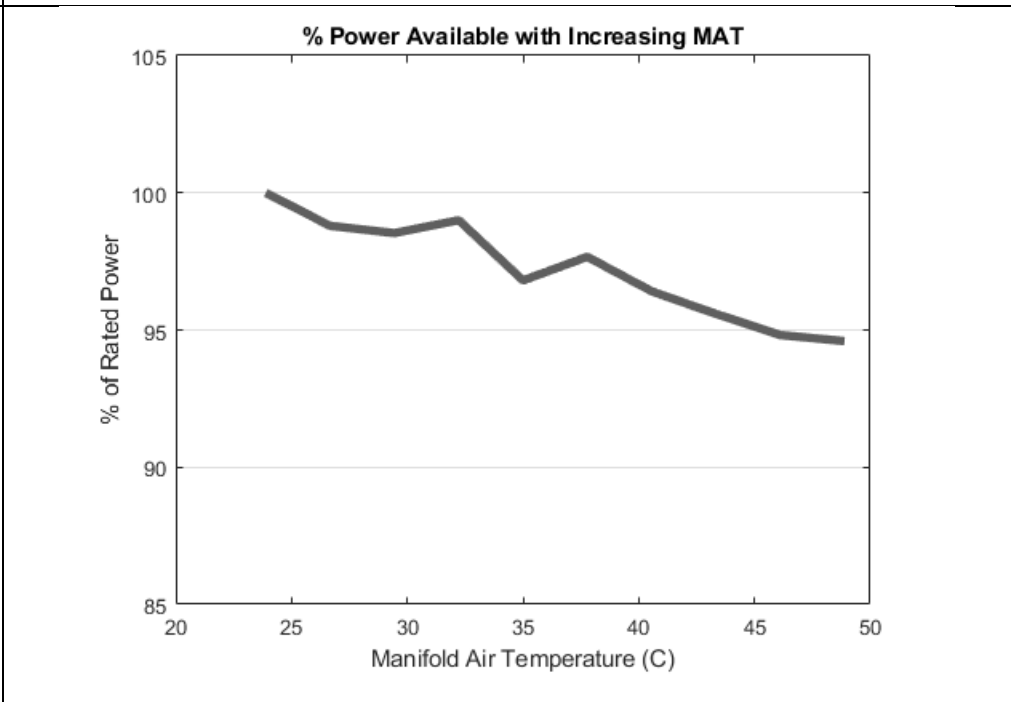

PARTS LIST

Coming soon.

WARRANTY

Thank you for choosing an HFE International.

Your Total satisfaction is our #1 priority.

If you have any questions on the installation and operation of this engine, please contact us directly. Please have your GenPod® serial number on hand when calling for service.

HFE International Fuel Injected Engine Customer Service:

Phone: 520.578.0818

Email: contactus@hfeinternational.com

**8060 E Research Ct.
Tucson, Arizona 85710
U.S.A**

Engine Core Warranty

Your DA150 motor and ignition system are covered with a 3 year warranty by Desert Aircraft, starting from the date of purchase.

- **This warranty covers defects in workmanship and materials only.**
- **Do not disassemble the motor or ignition system. Disassembly of the motor or ignition system can void the warranty on that item.**
- **Any modifications to the motor, or the ignition system, other than those authorized by Desert Aircraft, will void this warranty.**

This warranty does not cover the following:

- **Shipping expenses to and from Desert Aircraft for warranty service.**
- **Damage caused by improper handling, operation, or maintenance.**
- **Damage caused by a crash.**
- **Damage caused by using improper fuel or additives.**
- **Damage incurred during transit to Desert Aircraft. WRAP AND PACK ENGINE CAREFULLY!!**

NOTE: DESERT AIRCRAFT WILL NOT SHIP ANY WARRANTY REPLACEMENT ITEMS UNTIL POSSIBLY DEFECTIVE ITEMS IN QUESTION ARE RECEIVED BY DESERT AIRCRAFT.

GenPod® System Warranty

Your GenPod® system is covered with a 1 year warranty by HFE International starting from the date of shipment.

This warranty covers defects in workmanship and materials only to include Fuel Pump, wiring, ECM and throttle body.

Do not disassemble the GenPod® assembly. Disassembly of the GenPod® assembly will void the warranty on that item.

Any modifications to the GenPod® assembly, other than those authorized by HFE International, will void this warranty.

This warranty does not cover the following:

- Shipping expenses to and from HFE International for warranty service.
- Damage caused by improper handling, operation, or maintenance.
- Damage caused by a crash.
- Damage caused by using improper fuel or additives.
- Damage incurred during transit to HFE International.

NOTE: HFE INTERNATIONAL WILL NOT SHIP ANY WARRANTY REPLACEMENT ITEMS UNTIL POSSIBLY DEFECTIVE ITEMS IN QUESTION ARE RECEIVED BY HFE INTERNATIONAL.